



# Estimates of the 2020 deer harvest in Victoria

Results from surveys of Victorian  
Game Licence holders in 2020

P.D. Moloney and J.S. Flesch  
September 2021

## Acknowledgment

We acknowledge Victorian Traditional Owners and their Elders past and present as the original custodians of Victoria's land and waters, including their connection to country and culture through hunting, and commit to genuinely partnering with them and Victoria's Aboriginal community to progress their aspirations.



**Citation:** Moloney, P.D. and Flesch, J.S. (2021). Estimates of the 2020 deer harvest in Victoria: results from surveys of Victorian Game Licence holders in 2020. Unpublished Client Report for the Game Management Authority. Arthur Rylah Institute for Environmental Research, Department of Environment, Land, Water and Planning, Heidelberg, Victoria.

**Front cover photo:** Red Deer stag (Michael Gibson).

ISSN 2652-7073 (pdf/online/MS word)

ISBN 978-1-76090-183-7 (pdf/online/MS word)

© The State of Victoria Game Management Authority 2020

### Disclaimer

This publication may be of assistance to you but the State of Victoria and its employees do not guarantee that the publication is without flaw of any kind or is wholly appropriate for your particular purposes and therefore disclaims all liability for any error, loss or other consequence which may arise from you relying on any information in this publication.

# **Estimates of the 2020 deer harvest in Victoria**

**Results from surveys of Victorian Game Licence holders  
in 2020**

**Paul D. Moloney<sup>1</sup> and Jason S. Flesch<sup>2</sup>**

<sup>1</sup>Arthur Rylah Institute for Environmental Research  
123 Brown Street, Heidelberg, Victoria 3084

<sup>2</sup>Game Management Authority  
89 Sydney Rd, Benalla, Victoria 3672

## Acknowledgements

This report was commissioned by the Game Management Authority. We thank the Game Licence holders who gave their time to participate in the surveys, which were conducted by Marketing Skill Pty Ltd (Mt Eliza, Victoria). We would also like to thank Luke Woodford and Simon Toop for making valuable comments on drafts of this report.

# Contents

<b>Acknowledgements</b>	<b>ii</b>
<b>Contents</b>	<b>iii</b>
<b>Summary</b>	<b>1</b>
<b>1 Introduction</b>	<b>3</b>
<b>2 Methods</b>	<b>3</b>
2.1 Holders of a Game Licence endorsed for hunting deer	3
2.2 Holders of a Game Licence endorsed for hunting deer by using hounds	5
<b>3 Results</b>	<b>6</b>
3.1 Overall deer harvest in 2020	6
3.2 Overall deer harvest using hounds in 2020	13
<b>4 Discussion</b>	<b>17</b>
4.1 Deer harvest in 2020	17
4.2 Deer harvest using hounds in 2020	20
4.3 Comparing deer harvest methods in 2020	20
4.4 Assumptions	21
<b>References</b>	<b>22</b>
<b>Appendices</b>	<b>23</b>
Appendix 1: Questionnaire for Game Licence holder endorsed to hunt deer	23
Appendix 2: Questionnaire for Game Licence holder endorsed to hunt deer using hounds	25
Appendix 3: Definitions and calculations	27
Appendix 4: Explanation of what goes into a boxplot	29
Appendix 5: Harvest rates per Game Licence endorsed for hunting deer	30
Appendix 6: Harvest rates per Game Licence holders endorsed for using hounds	31

## Tables

Table 1.	Summary of responses for deer surveys in 2020 .....	6
Table 2.	Proportions and corresponding total numbers of Game Licence holders who hunted in each survey period in 2020 .....	6
Table 3.	Average harvest of deer per hunter (Game Licence holder who hunted) for each survey period in 2020 .....	7
Table 4.	Estimates of the total deer harvest in Victoria by Game Licence holders in 2020 .....	8
Table 5.	Estimates of annual deer hunting in Victoria in 2020 by Game Licence holders who hunted at least once.....	8
Table 6.	Estimated total harvest per deer species for each survey period in 2020.....	9
	a. Sambar Deer.....	9
	b. Fallow Deer .....	9
	c. Red Deer .....	10
	d. Rusa Deer.....	10
Table 7.	Reported numbers and percentages of each sex for each deer species harvested in 2020 .....	11
Table 8.	Estimated numbers of days on which deer were hunted by Game Licence holders in 2020 .....	11
Table 9.	Percentage of days of hunting and deer harvest by land tenure in 2020 .....	11
Table 10:	Percentage of total hunting days for deer harvested by hunting method and land tenure in 2020 .....	12
Table 11.	Summary of responses from 2020 Game Licence holders endorsed to use hounds.....	13
Table 12.	Total numbers (and corresponding proportions) of Game Licence holders endorsed for using hounds and who actually used hounds for each survey period in 2020 .....	13
Table 13.	Estimates of the average number of deer harvested per team member (as reported by Game Licence holders who hunted using hounds) for each survey period in 2020.....	14
Table 14.	Estimates of the total deer harvested using hounds in Victoria in 2020 by holders of a deer Game Licence endorsed for using hounds.....	15
Table 15.	Annual estimates of deer harvested using hounds in Victoria in 2020 by active Game Licence holders endorsed for using hounds .....	15
Table 16.	Total number of days on which teams hunted using hounds in 2020 by survey period ....	16
Table 17.	Deer harvested and hunting days per Game Licence holder for 2009–2020 .....	19
Table 18.	Comparison of the 2009–2020 harvests of the six game deer species.....	19
Table 19:	Comparison of deer harvests using scent-trailing hounds from 2018 to 2019. ....	20
Table A5.1:	Estimates of average harvest of deer per Game Licence holder in each survey period in 2020 .....	30
Table A5.2:	Number of days on which deer were hunted per Game Licence holder for 2020 .....	30
Table A6.1:	Estimates of average harvest of deer per Game Licence holder using hounds in each survey period in 2020.....	31
Table A6.2:	Number of days on which deer were hunted using hounds per Game Licence holder endorsed for using hounds for 2020 .....	31

## Figures

Figure 1.	Boxplot of the number of deer reported as harvested by individual hunters for each survey period in 2020.....	7
Figure 2.	Estimated total deer harvest for each 2-month survey period in 2020 by species.....	9
Figure 3.	Estimates of the total deer harvested in 2020 by CMA region. ....	12
Figure 4.	Boxplot of the number of deer reported harvested by hound teams for each survey period in 2020. ....	14
Figure 5.	Estimates of total deer harvested using hounds in 2020 by CMA region.....	16
Figure 6.	Estimates of total deer harvested (in thousands) from 2009 to 2020.....	18
Figure A4.1:	Example boxplot, with labels .....	29

## Summary

### Context:

To effectively manage game species, it is important to quantify the numbers harvested. To ascertain levels of deer harvested, since 2009, Victorian State Government game management agencies have commissioned a series of regular telephone surveys of randomly selected Game Licence holders endorsed to hunt deer during the game hunting season. Additional telephone surveys were commissioned, starting in 2018, to quantify the scale of Sambar Deer hunting deer by using hounds. This report focuses on the total recreational deer harvest for 2020. Deer destroyed in commercial culling activities or as part of damage mitigation programs are not considered.

### Aims:

The aim of this report was to provide estimates of the total harvest of deer by hunters licenced in Victoria during the 2020 hunting season.

### Methods:

Game Licence holders endorsed to hunt deer, and Game Licence holders endorsed to hunt Sambar Deer by using hounds, were randomly sampled and interviewed by telephone at intervals during their respective game seasons. In all surveys, respondents were asked whether they had hunted during the period for which the survey applied, and (if applicable) the number and species of deer harvested. Additional information was obtained on hunting methods and locations. Surveys at the end of the season were used to quantify the proportion of Game Licence holders who hunted at some stage of the season.

### Results:

The total deer harvest in 2020 was estimated to be approximately 69,900 [95% confidence interval (CI) = 50,300–97,100], which was 60% less than that of 2019 (the year with the highest estimate) and within 10% of the average since 2009 (76,400). The decrease in the deer harvest can be explained by a 42% decrease in the proportion of active hunters and a 26% decrease in the number of hunting days per active hunter; hunter efficiency (deer harvest per day) remained consistent with the previous two years. 'Active hunters' refers to those Game Licence holders with endorsement for deer hunting who hunted at least once in 2020.

In 2020, 35% of Game Licence holders endorsed to hunt deer actively hunted. On average, active deer hunters harvested an estimated 4.9 deer over 10.1 days.

The most commonly harvested species was Sambar Deer (with an estimated total harvest of 50,635, or 72% of the harvest, mainly on public land), followed by Fallow Deer (11,372, or 16%, mainly on private land). These species percentages are similar to those of previous years.

In 2020, the total number of deer harvested using hounds was estimated to be 9700 (95% CI = 7900–11,900). The average annual deer harvested by using hounds per active Game Licence holder endorsed to hunt Sambar Deer with hounds was 4 (95% CI = 3.1–5.2), which is less than the overall rate per active hunter (4.9). The efficiency of deer harvesting using hounds (0.5 deer per hunting day per team member) was approximately the same as the overall deer-harvesting efficiency (0.49) in 2020.



## Conclusions and implications:

1. The 2020 deer hunting season was the first season since 2013 in which the deer harvest did not increase.
  - The number of deer harvested decreased by 60% from the previous year.
  - The number of deer hunting days decreased by 58% from the previous year.
  - The number of deer harvested using hounds decreased by 61% from the previous year.
  - The number of deer hunting days using hounds decreased by 65% from the previous year.
2. Much of the reduction in deer harvest can be attributed to the unusual circumstances of 2020.
  - Access to hunting areas was restricted due to the Black Summer bushfires and COVID-19 lockdowns.
  - The decreases in deer harvested in 2020 were related to reduced hunter activity (42% decrease) and reduced hunting days (26% decrease), even when active.
  - However, hunter efficiency was consistent with the previous two years. (0.49 deer harvested per hunter per hunting day)
3. Hunter efficiency remained high in 2020, suggesting that, if hunter activity returns to pre-2020 levels, then the harvest numbers may return to pre-2020 levels as well.
4. Performing telephone surveys throughout the year is likely to minimise memory bias and non-response bias. However, sources of bias will remain (due to over- and under-reporting), and the estimates of total harvest must be interpreted with care.

## 1 Introduction

To effectively manage game species, it is important to quantify the numbers harvested. Since 2009, the State Government's game management agency has commissioned a series of regular telephone surveys of randomly selected Game Licence holders. Three sets of telephone surveys were conducted during the various game harvest seasons for deer, duck and quail, respectively. This report focuses only on the deer harvests.

Recreational deer hunting occurs all year round in Victoria for all game deer species except for Hog Deer (Game Management Authority 2018). The 2020 deer hunting reporting periods were selected to divide the whole year into 2-month periods within the calendar year. Sambar Deer (*Cervus unicolor*) can be hunted all year by stalking. Use of hounds is restricted to hunting of Sambar Deer between 1 April and 30 November. There is no limit on the number of Sambar Deer that can be taken by either method. Hog Deer (*Axis porcinus*) can only be hunted during April (excluding out-of-season ballot hunting) and is subject to additional restrictions, such as one male and one female per hunter. All other species can be hunted all year, with no bag limit, including: Fallow Deer (*Dama dama*), Red Deer (*Cervus elaphus*), Chital Deer (*Axis axis*) and Rusa Deer (*Rusa timorensis*).

The survey methods employed in this study involved the same kind of telephone surveys as those conducted during the 2018 and 2019 deer-hunting seasons (Moloney and Powell 2019; Moloney and Hampton 2020) and telephone surveys similar to the those of the 2009 to 2017 deer-hunting seasons (Gormley and Turnbull 2009, 2010, 2011; Moloney and Turnbull 2012, 2013, 2014, 2016, 2017, 2018). Since 2018, a secondary survey has been conducted among those Game Licence holders endorsed for hunting Sambar Deer with hounds.

The aim of this report was to provide estimates of the total harvest of deer by Victorian hunters during the 2020 hunting season.

## 2 Methods

All surveys were conducted by the telephone survey company Marketing Skill Pty Ltd (Mt Eliza, Victoria) on behalf of the Game Management Authority. Estimates of total harvests by Game Licence holders were based on the hunting activities reported by the survey respondents.

### 2.1 Holders of a Game Licence endorsed for hunting deer

A telephone survey was conducted every 2 months and involved 200 respondents<sup>1</sup> from a random sample of holders of a Game Licence endorsed for hunting deer (hereafter referred to as 'Game Licence holders'). Respondents were asked to report on their hunting activities for the preceding 2-month period, including the number and sex of each species of deer harvested during that period. Although a respondent may have hunted during the periods covered by the March–April and May–June Surveys, if they were contacted as part of May–June Survey, information was only collected that pertained to the period covered by the May–June Survey. During each survey, the 200 respondents were interviewed, regardless of whether they had hunted or not.

An additional random sample of 400 Game Licence holders were surveyed immediately after the conclusion of the 2020 hunting season. They were asked whether they had hunted at any stage during the 2020 season. The number of active hunters was estimated from their responses.

The information from the 200 respondents surveyed 2-monthly and the estimated number of active hunters were used to generate total harvest estimates for the whole population of Game Licence holders. Estimates of harvests of each species of deer were determined for each of the survey periods and were summed to give an estimate of the total season harvests.

---

<sup>1</sup> Respondent refers to a Game Licence holder who was contacted and agreed to take part in the survey.

For each survey period, the proportion of respondents who hunted was used as an estimate of the proportion of Game Licence holders who hunted. The proportion of the Game Licence holders surveyed who had hunted during each survey period was multiplied by the total number of Game Licence holders for that period, yielding the estimated total number of hunters for that survey period.

For each survey period, the average harvest per hunter<sup>2</sup> was estimated from the total reported harvest divided by the number of respondents who hunted. The total harvest for each survey period was estimated by multiplying the average harvest per hunter by the previously estimated total number of hunters for that survey period. Finally, the total season harvest was estimated from the sum of the survey-specific total harvests.

The annual harvest per Game Licence holder was also estimated. For each survey period, the average harvest per survey respondent was estimated by multiplying the average harvest per hunter by the proportion of respondents that hunted. The sum of these estimates across the year provided an estimate of the annual harvest per Game Licence holder endorsed to hunt deer.

Respondents who hunted were also asked to provide information on whether hunting was conducted on private land or public land, the name of the town nearest to where they hunted, what hunting methods they had used (i.e. stalking, hounds, or gun dogs / deer hunting dogs), and the number of days they hunted during the survey period. Regional harvest estimates were calculated by summing the reported harvest for each town, then aggregating these for the corresponding Victorian Catchment Management Authority (CMA) region.

Due to a change in systems, the actual number of Game Licence holders was not recorded for the first two surveys of 2020. To estimate the number of licence holders in January–February 2021, we used the fact that there is typically a 17.6% decrease (based on data from previous deer harvesting reports) from November–December of one year to the January–February of the next year. To estimate March–April, the average of the predicted January–February and actual May–June number of licence holders was used. This means that the estimates of number of active hunters, number of hunting days and total harvest from January–February and March–April need to be treated with caution.

Additional details of the methods and examples of the calculations are provided in Appendices 1–3 and 5–6. A description and interpretation of boxplots is provided in Appendix 4.

---

<sup>2</sup> Hunter refers to a Game Licence holder who actually went out and hunted (successfully or unsuccessfully) at some point during the period with which the survey was concerned.

## 2.2 Holders of a Game Licence endorsed for hunting deer by using hounds

A telephone survey was conducted every 2 months during the hound hunting season and involved 100 respondents from a random sample of holders of a Game Licence endorsed for hunting deer by using hounds (hereafter referred to as 'Game Licence holders endorsed for using hounds'). Respondents were asked to report on their hunting activities for that 2-month period, including the number and sex of each species of deer harvested, whether hounds were used, and team size. Although a respondent may have hunted during the periods covered by Surveys 2 and 3, if they were contacted as part of Survey 3, then information was only collected that pertained to the period covered by Survey 3. In each survey, the 100 respondents were interviewed, regardless of whether they had hunted or not. An additional random sample of 400 Game Licence holders endorsed for using hounds were surveyed immediately after the conclusion of the 2020 hound hunting season. They were asked whether they had hunted with hounds at any stage during the 2020 hound hunting season. The number of 'active hound hunters' was estimated from their responses.

The information provided by the hound hunting respondents was used in a similar way to that of the general Game Licence holders. However, hound hunting usually happens in teams of 2 or more hunters. The personal deer harvest in a hound hunting team may not be evenly spread across all members of the team. For example, a team of 3 hound hunters harvest 4 deer in total, with one person harvesting 3 deer, another 1 deer and the last having no deer. Depending on which person was the respondent, if we use personal harvest the result could be 0, 1 or 3 deer. Instead of using the harvest total for the respondent for the period, the total harvest per team member across all hunting trips across the survey was used. Hence for the previous example, whichever person was the respondent, the results would be  $1.\bar{3}$  deer (4 total deer divided by the 3 team members).

This allowed for the estimate to be scaled up according to the number of Game Licence holders endorsed for using hounds to yield an estimate of the total Sambar Deer harvest in which hounds were used. Further information, including team size and non-hound hunting harvest, was also obtained from the survey responses.

Due to a change in systems, the actual number of Game Licence holders endorsed for using hounds in 2020 was not recorded until June 2020. Because of the limited data, the number of Game Licence holders using hounds in April–May 2020 was assumed to be the same as the number recorded for June 2020. This means that the estimates of number of active hunters, number of hunting days and total harvest from April–May need to be treated with caution.

## 3 Results

### 3.1 Overall deer harvest in 2020

The number of Game Licence holders dipped slightly in the middle of 2020 (Table 1). To achieve the required sample size of respondents, slightly more than 200 licence holders were contacted each survey. An average of 98% of those contacted were willing to take part.

The proportion of Game Licence holders who hunted in each survey period varied across the year: approximately 9000 Game Licence holders (22%) hunted in September–October, whereas 8% of Game Licence holders hunted in November–December (Table 2). The proportion who hunted during other survey periods varied between 12% and 21% (Table 2).

**Table 1. Summary of responses for deer surveys in 2020**

Deer survey	Period	Licence holders	Respondents	Respondents who hunted	Days hunted <sup>3</sup>	Deer harvested <sup>4</sup>
1	Jan-Feb	34,612	200	24	83	28
2	Mar-Apr	36,888	199	24	92	72
3	May-Jun	39,163	200	42	160	86
4	Jul-Aug	39,903	200	33	128	68
5	Sep-Oct	40,492	200	44	225	85
6	Nov-Dec	41,056	200	17	47	20

**Table 2. Proportions and corresponding total numbers of Game Licence holders who hunted in each survey period in 2020**

Period	Proportion	SE	95% CI		Total hunters	SE	95% CI	
			Lower	Upper			Lower	Upper
Jan–Feb	0.12	0.023	0.08	0.17	4,153	795	2,863	6,025
Mar–Apr	0.12	0.023	0.08	0.17	4,449	852	3,067	6,452
May–Jun	0.21	0.029	0.16	0.27	8,224	1,128	6,294	10,747
Jul–Aug	0.16	0.026	0.12	0.22	6,584	1,047	4,830	8,975
Sep–Oct	0.22	0.029	0.17	0.29	8,908	1,186	6,870	11,551
Nov–Dec	0.08	0.020	0.05	0.13	3,490	810	2,228	5,466

Within each survey period, there was great variation in the reported harvest of deer per ‘hunter’ (i.e. per Game Licence holder who hunted). Some hunters harvested more than 5 deer in a survey period, whereas at least one-quarter did not harvest any deer within that period (Figure 1).

The median number of deer harvested per hunter in a 2-month period was 1 deer. The average number of deer per hunter varied throughout the season (Table 3). The average harvest per hunter in 2020 ranged from a high of 3 deer in March–April to a low of 1.17 in January–February.

<sup>3</sup> Days hunted indicates the combined number of days on which deer hunting took place by respondents.

<sup>4</sup> Deer harvested indicates total number of deer harvested by respondents.

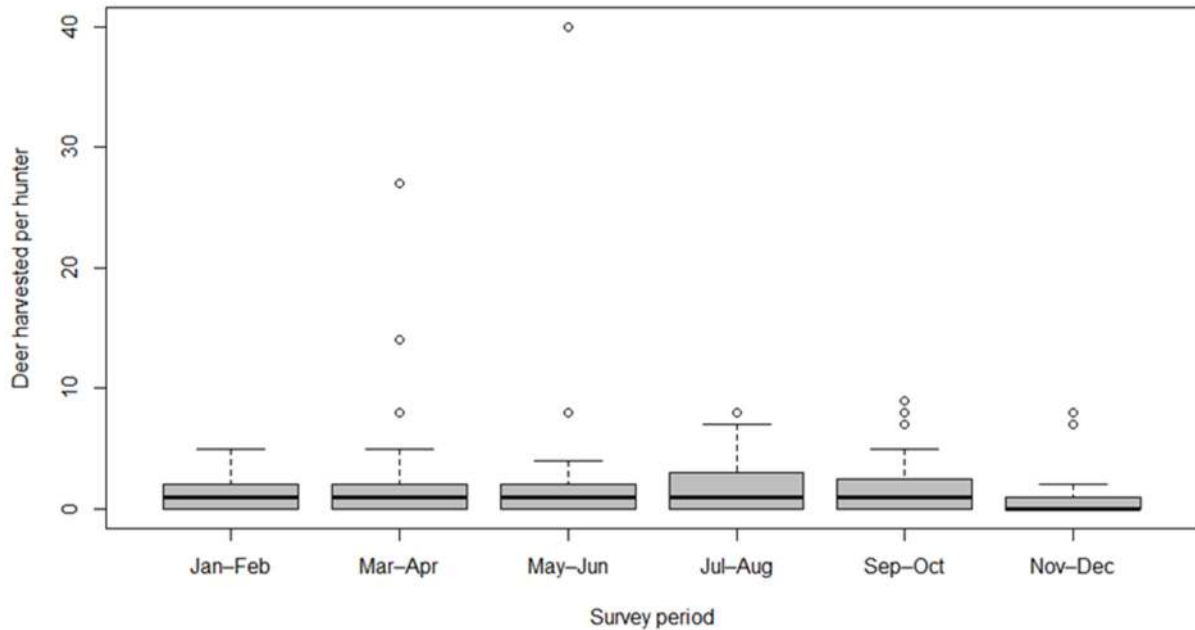

**Figure 1. Boxplot of the number of deer reported as harvested by individual hunters for each survey period in 2020.**

The bottom and top of each 'box' indicate the 25th and 75th percentiles, respectively, and the black horizontal line indicates the median (50th percentile) reported value.

**Table 3. Average harvest of deer per hunter (Game Licence holder who hunted) for each survey period in 2020**

Period	Average harvest per hunter <sup>5</sup>	SE	95% CI	
			Lower	Upper
Jan–Feb	1.17	0.30	0.71	1.91
Mar–Apr	3.00	1.23	1.39	6.49
May–Jun	2.05	0.96	0.86	4.89
Jul–Aug	2.06	0.40	1.42	3.00
Sep–Oct	1.93	0.38	1.32	2.83
Nov–Dec	1.18	0.60	0.46	3.00

There was an estimated total of 69,914 deer harvested from January 2020 to December 2020, inclusive, by Game Licence holders (95% CI = 50,335–97,108; Table 4). Harvest was greatest in the autumn to spring months and lowest in the summer months.

From the results of the telephone survey conducted immediately after the 2020 deer season, it was estimated that 35% (95% CI = 30%–40%) of Game Licence holders actually hunted for deer during 2020 (Table 5).

That equates to an estimated 14,267 (95% CI = 12,476–16,315) active deer hunters<sup>6</sup> in 2020. The average annual deer harvest per active deer hunter was estimated to be 4.9 (95% CI = 3.4–7.0). The average annual hunting days per active deer hunter was estimated to be 10.1 (95% CI = 7.8–13.0). The annual average is lower than the sum of each period (Table 3) because not all active hunters hunted in each period.

<sup>5</sup> Average harvest per hunter = Deer harvested divided by Respondents who hunted (Table 1).

<sup>6</sup> Active deer hunters are Game Licence holders endorsed to hunt deer who have hunted at least once during the season.

**Table 4. Estimates of the total deer harvest in Victoria by Game Licence holders in 2020**

Period	Total harvest <sup>7</sup>	SE	95% CI	
			Lower	Upper
Jan–Feb	4,846	1,550	2,628	8,934
Mar–Apr	13,346	6,030	5,735	31,061
May–Jun	16,840	8,195	6,822	41,569
Jul–Aug	13,567	3,398	8,366	22,002
Sep–Oct	17,209	4,075	10,887	27,201
Nov–Dec	4,106	2,286	1,483	11,370
<b>Total</b>	<b>69,914</b>	<b>11,802</b>	<b>50,335</b>	<b>97,108</b>

**Table 5. Estimates of annual deer hunting in Victoria in 2020 by Game Licence holders who hunted at least once**

Statistic	Annual estimate	SE	95% CI	
			Lower	Upper
Proportion active	0.35	0.02	0.30	0.40
Estimated number of active hunters	14,267	977	12,476	16,315
Average annual deer harvest per active hunter	4.90	0.89	3.44	6.98
Average hunting days per active hunter	10.06	1.34	7.76	13.04

Separate harvest estimates for each deer species are presented in Figure 2 and Table 6. The most frequently harvested species was Sambar Deer, comprising 72% of the total reported harvest, followed by Fallow Deer (16%) and Red Deer (2%). Rusa Deer accounted for less than 1% of the reported deer harvest. No Chital Deer or Hog Deer were reported harvested in the 2020 telephone survey. At the time of this report, there were no known wild populations of Rusa or Chital Deer in Victoria. There was also a hunter who reported harvesting 20 sambar and fallow deer in a survey period but did not specify the number of each species. This created a discrepancy in the estimated cumulative total of deer harvested by species (Table 6) and in the percentage that each species contributed to the total estimated harvest.

Even though no survey respondent reported harvesting Hog Deer in 2020, a total of 46 Hog Deer (39 stags and 7 hinds) were recorded in harvest returns. Of these, 24 were from the Snake Island, Boole Poole and Blond Bay balloted hunts (21 stags and 3 hinds).

Due to COVID-19 restrictions, these balloted hunts only ran for 4 periods (out of a usual 7), and outside of this the usual requirement to present harvested animals to authorised Hog Deer Checking Stations was not imposed by the Game Management Authority, so the total number of Hog Deer harvested in 2020 is unknown. There were, however, 22 animals checked in by hunters over the phone in the regular season (14 stags and 3 hinds), and 5 animals (4 stags and 1 hind) taken after the season on private property under special authorisation.

<sup>7</sup> Total harvest = Harvest per hunter (Table 3) × Total hunters (Table 2). Numbers may differ slightly due to rounding of average harvest per hunter.

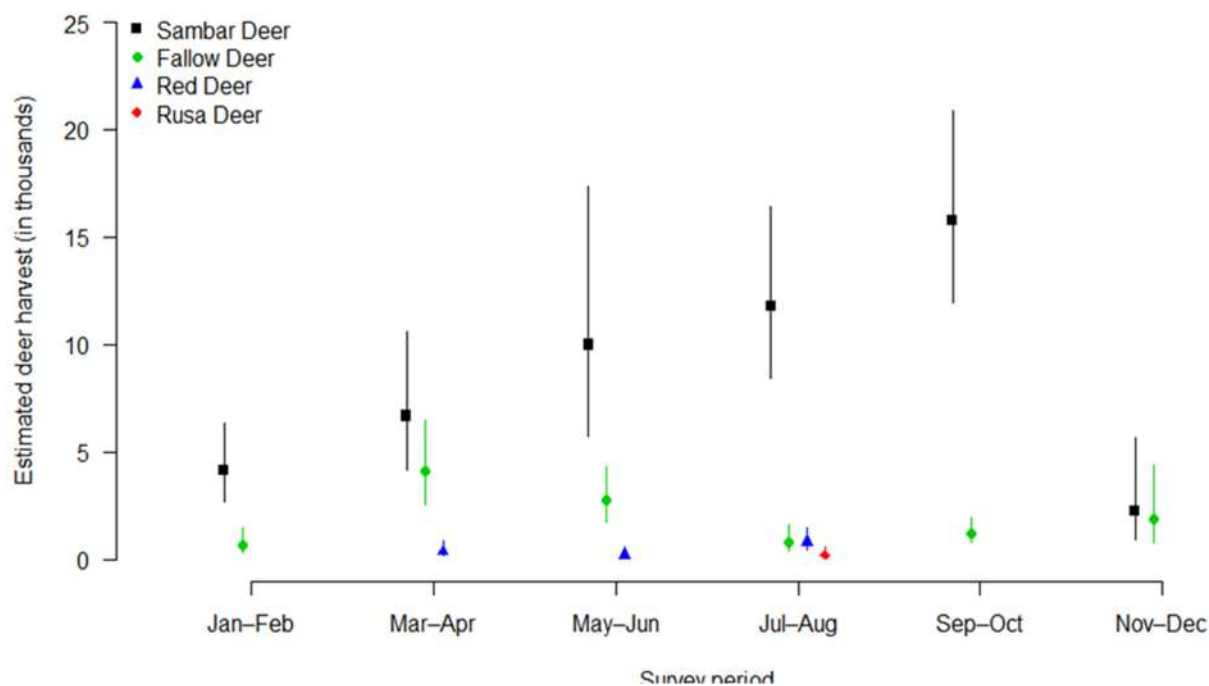

**Figure 2. Estimated total deer harvest for each 2-month survey period in 2020 by species.**

Vertical bars indicate 95% confidence intervals. Species were only included in surveys periods when they were reported.

**Table 6. Estimated total harvest per deer species for each survey period in 2020**

**a. Sambar Deer.**

Period	Reported harvest	Estimated harvest	SE	95% CI	
				Lower	Upper
Jan-Feb	24	4,153	908	2,720	6,342
Mar-Apr	36	6,673	1,606	4,192	10,624
May-Jun	51	9,987	2,868	5,751	17,341
Jul-Aug	59	11,771	2,019	8,431	16,435
Sep-Oct	78	15,792	2,268	11,934	20,897
Nov-Dec	11	2,258	1,113	905	5,633
<b>Total</b>	<b>259</b>	<b>50,635</b>	<b>4,700</b>	<b>42,228</b>	<b>60,715</b>

**b. Fallow Deer**

Period	Reported harvest	Estimated harvest	SE	95% CI	
				Lower	Upper
Jan-Feb	4	692	285	319	1,504
Mar-Apr	22	4,078	982	2,560	6,495
May-Jun	14	2,741	650	1,734	4,335
Jul-Aug	4	798	294	396	1,607
Sep-Oct	6	1,215	286	771	1,914
Nov-Dec	9	1,848	862	774	4,408
<b>Total</b>	<b>59</b>	<b>11,372</b>	<b>1,542</b>	<b>8,728</b>	<b>14,817</b>



### c. Red Deer

Period	Reported harvest	Estimated harvest	SE	95% CI	
				Lower	Upper
Jan–Feb	0	0	NA	NA	NA
Mar–Apr	2	371	170	157	873
May–Jun	1	196	126	62	621
Jul–Aug	4	798	250	438	1,454
Sep–Oct	0	0	NA	NA	NA
Nov–Dec	0	0	NA	NA	NA
<b>Total</b>	<b>7</b>	<b>1,365</b>	<b>328</b>	<b>858</b>	<b>2,171</b>

### d. Rusa Deer

Period	Reported harvest	Estimated harvest	SE	95% CI	
				Lower	Upper
Jan–Feb	0	0	NA	NA	NA
Mar–Apr	0	0	NA	NA	NA
May–Jun	0	0	NA	NA	NA
Jul–Aug	1	200	114	71	565
Sep–Oct	0	0	NA	NA	NA
Nov–Dec	0	0	NA	NA	NA
<b>Total</b>	<b>1</b>	<b>200</b>	<b>114</b>	<b>71</b>	<b>565</b>

There was a statistically significant sex bias favouring females for the harvest of Fallow Deer (Table 7). There was no statistically significant sex bias for the harvest of Sambar Deer or Red Deer.

The number of days of hunting in each survey period varied throughout the season, with most hunting occurring from late-autumn to mid-spring. Each Game Licence holder endorsed to hunt deer who was active hunted an average of 10.1 days during 2020, corresponding to a total of 143,488 hunter days (95% CI = 114,800–179,344; Table 8).

**Table 7. Reported numbers and percentages of each sex for each deer species harvested in 2020**

Species	Males			Females		
	Reported	%	SE	Reported	%	SE
Sambar Deer	115	44	3	144	56	3
Fallow Deer	16	27	6	43	73	6
Red Deer	4	57	19	3	43	19

**Table 8. Estimated numbers of days on which deer were hunted by Game Licence holders in 2020**

Period	Days hunted per Game Licence holder	SE	95% CI	
			Lower	Upper
Jan–Feb	14,364	4,396	7,991	25,820
Mar–Apr	17,054	5,649	9,061	32,098
May–Jun	31,330	7,431	19,807	49,558
Jul–Aug	25,538	6,193	15,985	40,799
Sep–Oct	45,554	10,509	29,153	71,179
Nov–Dec	9,648	3,625	4,733	19,668
<b>Total hunting days</b>	<b>143,488</b>	<b>16,383</b>	<b>114,800</b>	<b>179,344</b>
<b>Total hunting days per active hunter</b>	<b>10.06</b>	<b>1.34</b>	<b>7.76</b>	<b>13.04</b>

More deer hunting occurred on public land only (57%) than occurred on private land only (28%) in 2020, and similar proportions of deer were harvested on private land only and on public land only (45% and 42%, respectively)

(Table 9). Most Sambar Deer were harvested on public land only (49%). Most Fallow Deer harvested were harvested on private land only (83%).

**Table 9. Percentage of days of hunting and deer harvest by land tenure in 2020**

Land tenure	Days	Total Deer harvest	Sambar Deer harvest	Fallow Deer harvest	Red Deer harvest	Rusa Deer harvest
Private land only	28.0	45.4	33.6	83.1	85.7	100
Public land only	57.1	41.5	49.4	11.9	14.3	0
Both	13.1	13.1	17.0	5.1	0.0	0
Not specified	1.8	0.0	0.0	0.0	0.0	0

Recorded use of gundogs was limited to under 5% of hunting days and deer harvested. It should be noted that on 23.7% of hunting days, respondents did not specify their hunting method and these were days on which hunting was unsuccessful.

This uncertainty will affect the reliability of the percentage of hunting days on which each method was used.

**Table 10: Percentage of total hunting days for deer harvested by hunting method and land tenure in 2020**

Land tenure		Scent-trailing hounds	Stalking	Stalking with gundog	Not specified	Total
Private land only	Days	0.1	22.3	0.1	5.4	<b>28.0</b>
	Deer	0.6	44.8	0.0	0.0	<b>45.4</b>
Public land only	Days	12.7	28.6	1.2	14.7	<b>57.1</b>
	Deer	15.3	24.0	2.2	0.0	<b>41.5</b>
Both	Days	0.4	9.4	1.5	1.8	<b>13.1</b>
	Deer	0.8	11.1	1.1	0.0	<b>13.1</b>
Not specified	Days	0.0	0.0	0.0	1.8	<b>1.8</b>
	Deer	0.0	0.0	0.0	0.0	<b>0.0</b>
<b>Total</b>	<b>Days</b>	<b>13.2</b>	<b>60.3</b>	<b>2.9</b>	<b>23.7</b>	<b>100.0</b>
	<b>Deer</b>	<b>16.7</b>	<b>79.9</b>	<b>3.3</b>	<b>0.0</b>	<b>100.0</b>

The total harvest was estimated to be greatest in the Goulburn Broken Catchment Management Authority (CMA) region, followed by the North East CMA region, and the Port Phillip and Westernport CMA region (Figure 3).

The top five towns for the total reported number of deer harvested were (in descending order) Mansfield, Kinglake Central, Omeo, Myrtleford and Warragul. The top five towns for the total number of reported deer hunting days were (in descending order) Mansfield, Bright, Jamieson, Omeo and Bairnsdale.

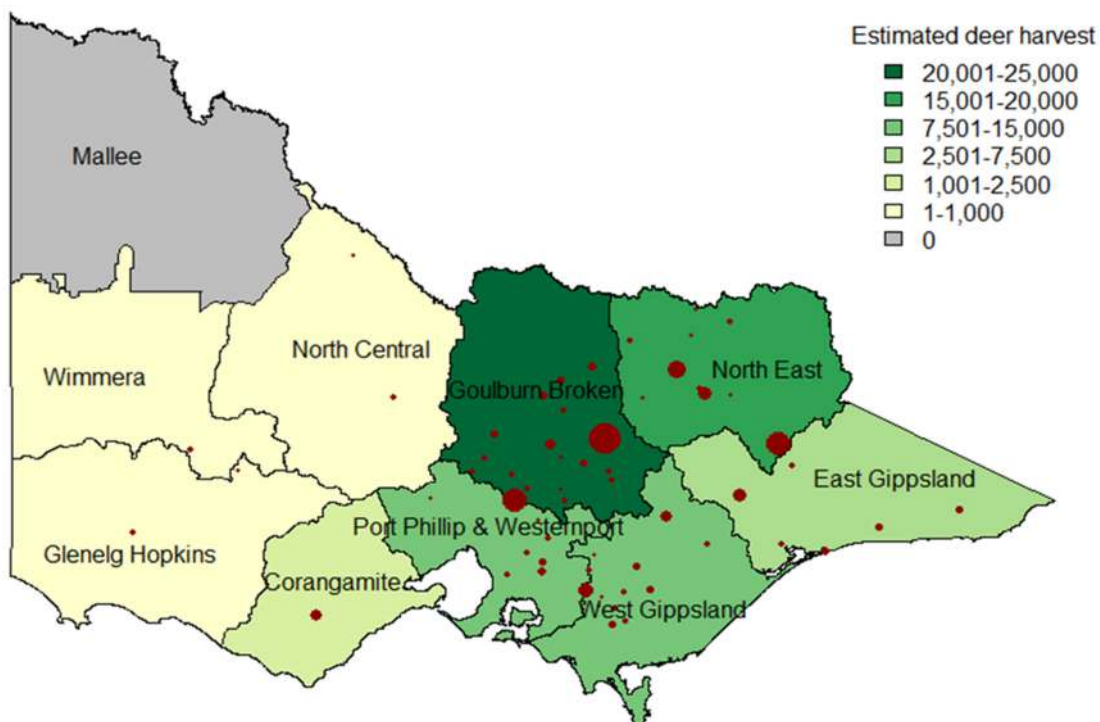

**Figure 3. Estimates of the total deer harvested in 2020 by CMA region.**

Red circles indicate the nearest town to harvest locations, with symbol size proportional to reported harvest.

### 3.2 Overall deer harvest using hounds in 2020

The number of Game Licence holders endorsed to hunt deer by using hounds was consistent throughout 2020, from 4968 in June to 5053 at the end of the season (Table 11). To achieve the required sample size of respondents, slightly more than 100 licence holders were contacted each survey, with an average of 97% of those contacted being willing to take part.

The proportion of Game Licence holders endorsed for using hounds who actually hunted with hounds varied between surveys, with the June–July period having a much greater proportion (29%) than the other survey periods (Table 12).

**Table 11. Summary of responses from 2020 Game Licence holders endorsed to use hounds**

Deer survey	Period	Licence holders	Respondents	Respondents who hunted	Days hunted	Deer harvested <sup>8</sup>
1	Apr–May	4,968	100	20	45	128
2	Jun–Jul	4,978	100	29	177	389
3	Aug–Sep	5,017	100	18	97	138
4	Oct–Nov	5,053	101	17	66	190

**Table 12. Total numbers (and corresponding proportions) of Game Licence holders endorsed for using hounds and who actually used hounds for each survey period in 2020**

Period	Proportion	SE	95% CI		Total hunters	SE	95% CI	
			Lower	Upper			Lower	Upper
Apr–May	0.20	0.040	0.14	0.29	994	199	674	1,465
Jun–Jul	0.29	0.045	0.21	0.39	1,444	226	1,064	1,958
Aug–Sep	0.18	0.038	0.12	0.27	903	193	597	1,366
Oct–Nov	0.17	0.037	0.11	0.26	851	188	554	1,305

<sup>8</sup> Deer harvested indicates the total number of deer harvested by hound teams of which the respondents were members.

Within each survey period, there was great variation in the reported number of deer harvested per hunter in the various hound hunting teams (i.e. hound team total per Game Licence holder who hunted). Some teams (10%) harvested more than 30 deer in a survey period, whereas 24% of teams harvested 1 deer or less in each period (Figure 4).

The median number of deer harvested per team in a 2-month period was 5 deer. The average number of deer per team member (as reported by hunters) varied throughout the season (Table 13). The average harvest per hunter in a team in 2020 ranged from a high of 3.4 deer in June–July to a low of 1.01 in April–May.

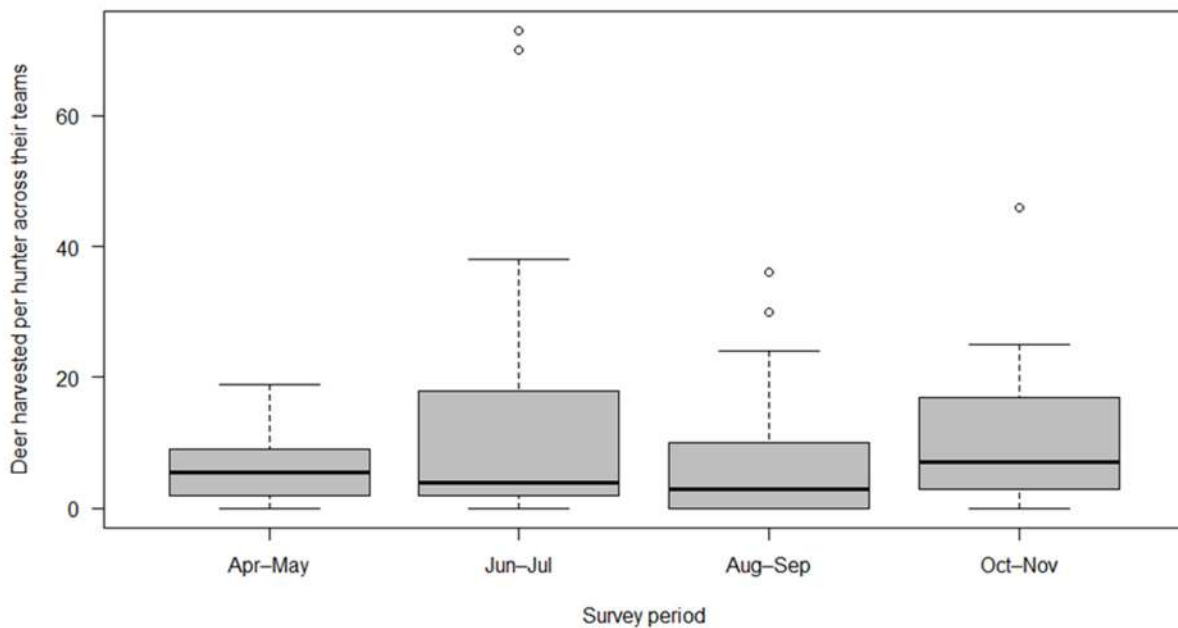

**Figure 4. Boxplot of the number of deer reported harvested by hound teams for each survey period in 2020.**

The bottom and top of each 'box' indicate the 25th and 75th percentiles, respectively, and the black horizontal line indicates the median (50th percentile) reported value.

**Table 13. Estimates of the average number of deer harvested per team member (as reported by Game Licence holders who hunted using hounds) for each survey period in 2020**

Period	Average harvest per hound hunter <sup>9</sup>	SE	95% CI	
			Lower	Upper
Apr–May	1.01	0.08	0.87	1.18
Jun–Jul	3.40	0.15	3.13	3.70
Aug–Sep	1.59	0.10	1.41	1.81
Oct–Nov	2.74	0.16	2.45	3.07

<sup>9</sup> Average harvest per hound hunter where the harvest per hunter is the sum of the deer harvested by the team divided by the number of team members for each team in which the respondent was involved.

There was an estimated total of 9694 deer harvested from April 2020 to November 2020, inclusive, by Game Licence holders endorsed for using hounds and who actually hunted using hounds (95% CI = 7869–11,942; Table 14). Approximately half the estimated total harvest occurred in the June–July period.

From the responses to the telephone survey undertaken immediately after the conclusion of the 2020 season for deer hunting using

hounds, it was estimated that 48% (95% CI = 41%–55%) of Game Licence holders endorsed for using hounds actually hunted with hounds during 2020 (Table 15). That equates to an estimated 2400 (95% CI = 2075–2776) active deer hunters using hounds<sup>10</sup> in 2020. The average number of deer harvested per active deer hunter using hounds was estimated to be 4 (95% CI = 3.1–5.2) over 2020.

**Table 14. Estimates of the total deer harvested using hounds in Victoria in 2020 by holders of a deer Game Licence endorsed for using hounds**

Period	Total harvest <sup>11</sup>	SE	95% CI	
			Lower	Upper
Apr–May	1,008	216	665	1,527
Jun–Jul	4,913	797	3,581	6,739
Aug–Sep	1,440	321	935	2,217
Oct–Nov	2,334	533	1,500	3,632
<b>Total</b>	<b>9,694</b>	<b>1,034</b>	<b>7,869</b>	<b>11,942</b>

**Table 15. Annual estimates of deer harvested using hounds in Victoria in 2020 by active Game Licence holders endorsed for using hounds**

Statistic	Annual estimate	SE	95% CI	
			Lower	Upper
Proportion active	0.48	0.04	0.41	0.55
Estimated number of active hunters	2,400	178	2,075	2,776
Average harvest per active hunter	4.04	0.53	3.13	5.21
Average hunting days per active hunter	8.01	1.47	5.60	11.45

<sup>10</sup> Active deer hunters using hounds are Game Licence holders endorsed to hunt deer using hounds and who have hunted at least once during the season.

<sup>11</sup> Total harvest = Harvest per hunter (Table 13) × Total hunters (Table 12). Numbers may differ slightly due to rounding of average harvest per hunter.

There was no significant evidence of a sex bias for Sambar Deer harvested by using hounds. The proportion of the harvest that was female was 52% (95% CI = 48%–55%).

The average number of hunting days with the use of hounds in each survey period varied throughout the season, with most hunting using hounds occurring in June and July. The total number of days of deer hunting using hounds in 2020 was 19,216 days (Table 16).

The total deer harvested using hounds was estimated to be greatest in the East Gippsland CMA region, followed by the Goulburn Broken CMA region and the North East CMA region (Figure 5). The top five towns for the total reported number of deer harvested using hounds were (in descending order) Dargo, Mansfield, Benalla, Myrtleford and Erica. The top five towns for the total number of reported deer hunting days using hounds were (in descending order) Dargo, Mansfield, Eildon, Erica and Benalla.

**Table 16. Total number of days on which teams hunted using hounds in 2020 by survey period**

Period	Days hunted	SE	95% CI	
			Lower	Upper
Apr–May	2,236	664	1,264	3,953
Jun–Jul	8,812	2,482	5,127	15,146
Aug–Sep	4,866	1,702	2,501	9,470
Oct–Nov	3,302	1,129	1,721	6,335
<b>Total number of days of hunting using hounds</b>	<b>19,216</b>	<b>3,282</b>	<b>13,782</b>	<b>26,792</b>

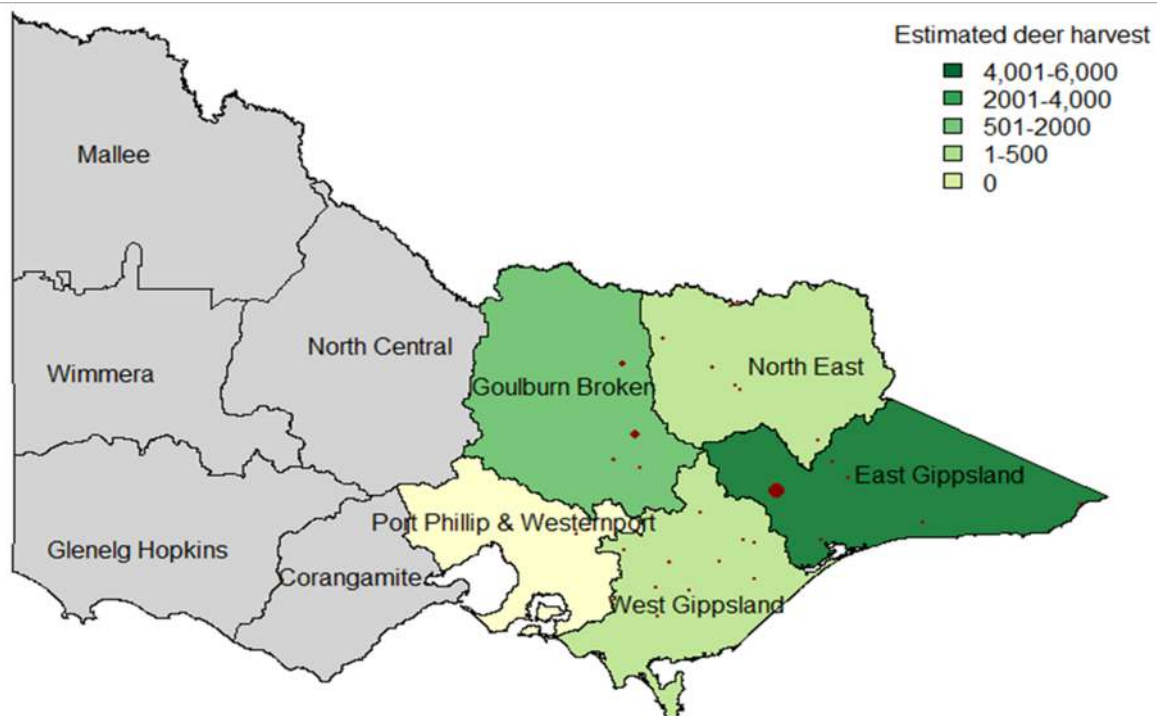

**Figure 5. Estimates of total deer harvested using hounds in 2020 by CMA region.**

Red circles indicate the nearest town to harvest locations, with symbol size proportional to reported harvest.

## 4 Discussion

The year 2020 started with the Black Summer fires, which affected large areas of Australia. In Victoria, these fires burnt large areas of bushland in the east of the state. Some of the affected regions included areas in which much of the deer hunting effort is typically spent. In addition, from March 2020 through to the end of the year, management of the COVID-19 pandemic involved a series of movement restrictions in Victoria. The unusual circumstances of 2020 appear to have resulted in a large reduction in the estimated deer harvest and number of hunting days. These reductions were due to reduced hunter activity, because the number of Game Licence holders and hunter efficiency remained steady.

### 4.1 Deer harvest in 2020

A total of 69,914 deer were estimated to have been harvested in Victoria during the 2020 calendar year (95% CI = 50,335–97,108). The 2020 estimate was within 10% of the average since 2009 (76,400) but significantly lower than from the previous year in 2019 (173,784). Prior to 2020, the estimated Victorian deer harvest had been increasing. The 2020 deer harvest was the smallest on record since 2015 (Table 17, Figure 6) and represented a 60% decrease from the previous year. The 2020 deer harvest was clearly against the recent trend over time.

The average number of Game Licence holders endorsed to hunt deer in 2020 (38,700) was similar to the number in 2019 (38,800). However, for the first time for the period of the telephone surveys, the number of licence holders in December (i.e. in the last survey of the year) decreased from one year to the next.

There was a large reduction in the proportion of hunters who actively hunted in 2020. The percentage of hunters who were active during the 2020 season was 35%. In 2017 to 2019 (the previous years for which this statistic was available) between 52% and 60% of licence holders were active at some point during the year (Table 17). The percentage of active hunters in any 2-month period in 2020 was 15%. In previous years, that figure ranged from 20% to 29%.

Hunter efficiency has been consistent over the past 3 years. The efficiency of hunters in 2020 was 0.49 deer harvested per hunting day, which is 28% greater than the average efficiency and very similar to efficiency estimated for the previous 2 years (Table 17).

The 2020 season had the smallest number of hunting days on record since 2013, and the third lowest since the telephone survey began. While the mean number of hunting days per active hunter in 2020 (10.1) was a 25.7% decline from 2019, it was similar to the figures for recent years. In 2017 to 2019 (the previous years for which this statistic was available), the estimated figure was between 9.1 and 13.6 hunting days per active hunter. Hence, the majority of the reduction in hunting days during 2020 was due to the reduced proportion of active hunters. There was also a relatively smaller reduction in hunting days due to there being fewer days per active hunter.

The estimated deer harvest per Game Licence holder in 2020 was 1.8, the smallest recorded since 2013 and the third smallest recorded since the surveys began; it was 30% lower than average and 60% less than the previous year. The estimated deer harvest per active hunter in 2020 was 4.9, 17% lower than recent years, but notably 28% lower than 2019. In 2017 to 2019 (the previous years for which this statistic was available), the estimated value was between 5.2 and 6.8 deer per active hunter.

The large reduction in deer hunting and harvest in 2020 seems to have been related to the unusual circumstances experienced in 2020. Hunter activity decreased in response to the Black Summer fires and the COVID-19-related movement and other restrictions (e.g. no overnight camping, reduced number of people permitted to gather). The proportion of hunters who were active was much lower than in previous years. Those who were active spent fewer days hunting. However, hunter efficiency remained high in 2020, suggesting that, if hunter activity returns to pre-2020 levels, then the harvest numbers may return to pre-2020 levels as well.



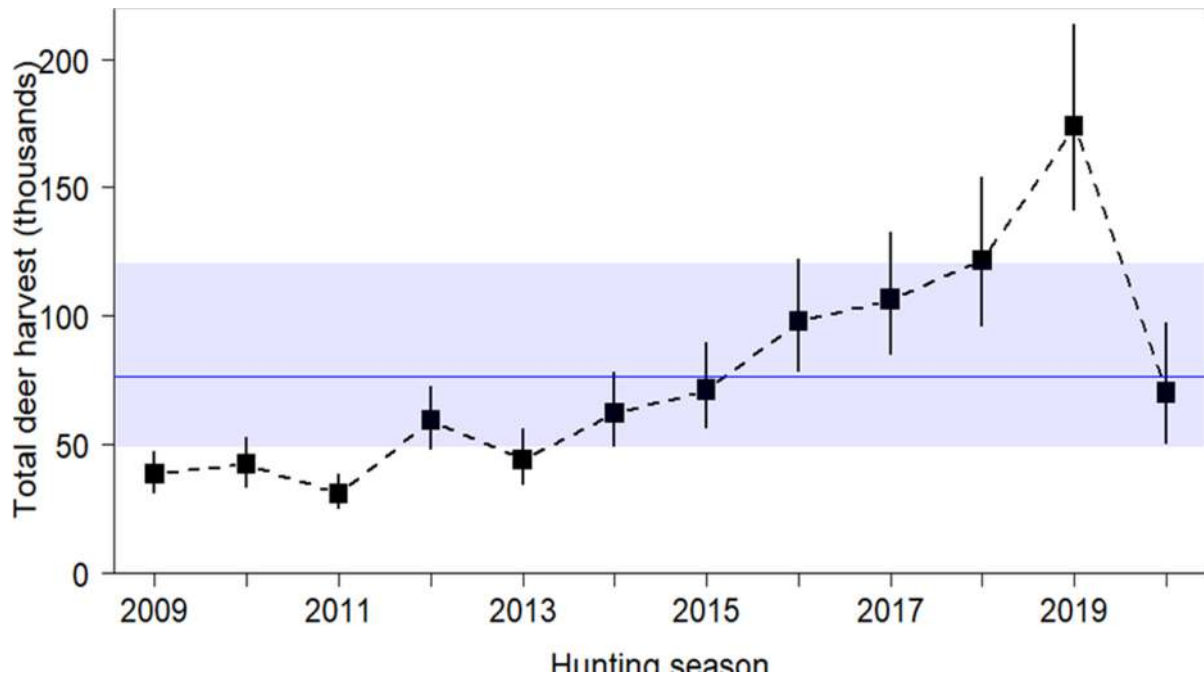

**Figure 6. Estimates of total deer harvested (in thousands) from 2009 to 2020.**

The square is the estimated total harvested for each season; the solid vertical line indicates the 95% confidence interval; the blue line is the average deer harvest from 2009 to 2020; the shaded area is the 95% confidence interval for the average deer harvest from 2009 to 2020.

The most commonly harvested species in 2020 was Sambar Deer (50,635), followed by Fallow Deer (11,372) and Red Deer (1365, Table 18). Rusa Deer accounted for less than 1% of the reported deer harvest. No Chital Deer or Hog Deer were reported harvested in the 2020 telephone survey.

At the time of this report, there were no known wild populations of Rusa or Chital Deer in Victoria, and it should be noted that the single Rusa Deer harvest reported in 2020 was on private land. Even though no survey respondent reported harvesting Hog Deer in 2020, a total of 46 Hog Deer (39 stags and 7 hinds) were reported harvested (see Section 3.1).

**Table 17. Deer harvested and hunting days per Game Licence holder for 2009–2020<sup>12</sup>**

Year	Total harvest	Total hunting days	Deer harvested per Game Licence holder	Hunting days per Game Licence holder	Deer harvested per hunting day	Proportion of active hunters
2009	38,284	150,321	2.14	8.38	0.25	NA
2010	42,133	149,002	2.12	7.56	0.28	NA
2011	30,753	135,278	1.43	6.30	0.23	NA
2012	59,206	169,721	2.62	7.54	0.35	NA
2013	43,985	135,854	1.76	5.47	0.32	NA
2014	62,166	186,215	2.22	6.68	0.33	NA
2015	71,141	201,547	2.36	6.77	0.35	NA
2016	97,776	207,614	3.12	6.63	0.47	NA
2017	106,275	184,317	3.11	5.45	0.58	0.55
2018	121,567	237,594	3.49	6.71	0.51	0.59
2019	173,784	344,604	4.48	8.86	0.50	0.60
2020	69,914	143,488	1.80	3.68	0.49	0.35
<b>Average</b>	<b>76,415</b>	<b>187,130</b>	<b>2.55</b>	<b>6.67</b>	<b>0.39</b>	<b>0.52</b>

**Table 18. Comparison of the 2009–2020 harvests of the six game deer species**

Year	Chital Deer	Fallow Deer	Hog Deer	Red Deer	Rusa Deer	Sambar Deer
2009	0	4,871	81	682	0	32,453
2010	0	6,085	454	1,396	0	34,108
2011	0	4,001	105	737	0	25,913
2012	0	9,788	102	555	0	48,048
2013	0	6,426	0	926	0	36,355
2014	0	7,870	0	745	0	51,390
2015	0	14,488	138	939	0	55,094
2016	129	15,059	0	1,713	0	80,875
2017	181	15,515	154	1,609	0	88,816
2018	0	30,552	0	2,101	0	88,202
2019	0	30,307	183	3,277	0	131,258
2020	0	11,372	0	1,365	200	50,635
<b>Average</b>	<b>26</b>	<b>13,028</b>	<b>101</b>	<b>1,337</b>	<b>17</b>	<b>60,262</b>

<sup>12</sup> Deer harvested and hunting days per Game Licence holder in 2020 are reported here for comparison with the results of surveys prior to 2017, when the deer harvested and hunting days per active hunter could be calculated.

## 4.2 Deer harvest using hounds in 2020

A total of 9694 deer were estimated to have been harvested using hounds in Victoria during the 2020 calendar year (95% CI = 7869–11,942). The 2020 deer harvest using hounds was 51% smaller than the average of previous seasons (Table 19). The deer harvest per active hunter using hounds was the lowest recorded and 50% smaller than the average of previous seasons.

The 2020 total number of days spent hunting with hounds (19,216) was 58% less than the average of previous seasons (Table 19). The hunting days per active hunter using hounds was the lowest recorded and 57% less than the average of previous seasons.

In 2020, hunter efficiency using hounds increased to 0.5, an 18% increase from the average of previous seasons (Table 19).

The decrease in deer harvest and hunting days per active hunter was a result of the reduced proportions of active hunters per survey period compared with previous years. The percentage of active hunters using hounds in any 2-month period in 2020 was 21%. In the previous 2 years, the percentages were 31% and 39%. The percentage of hunters who used hounds at least once during the 2020 season was average (Table 19).

**Table 19: Comparison of deer harvests using scent-trailing hounds from 2018 to 2019.**

Year	Proportion of active hunters	Total harvest	Total hunting days	Deer per active hunter	Hunting days per active hunter	Deer per hunting day
2018	0.52	14,670	36,416	5.69	14.14	0.40
2019	0.46	24,866	54,828	10.53	23.22	0.45
2020	0.48	9,694	19,216	4.04	8.01	0.50
<b>Average</b>	<b>0.48</b>	<b>16,410</b>	<b>36,820</b>	<b>6.75</b>	<b>15.12</b>	<b>0.45</b>

## 4.3 Comparing deer harvest methods in 2020

It should be noted that the survey of Game Licence holders endorsed for using hounds also asked about any hunting by stalking they had undertaken during the same period. The responses from this cohort showed that a lower proportion hound hunted (21%) than stalked (25%), while 8% did both within the 2-month period. The responses also showed that the harvest rate was similar for each method (2.5 deer harvested per team member using hounds, compared with 2.3 deer harvested per active hunter using stalking, respectively) over the same period of time. Game Licence holders using hounds spent an average of 8.7 days hunting deer, including use of hounds (4.9 days) and stalking (3.8 days).

In 2020, Game Licence holders endorsed to hunt deer using hounds were as efficient when using hounds as hunters in general. When using hounds, their efficiency was 0.5 deer harvested per team member per hunting day. From the survey of the general Game Licence holders endorsed to hunt deer, the efficiency was 0.49 deer harvested per hunting day. However, the average efficiency of Game Licence holders endorsed for using hounds was greater when they were stalking (0.59 deer per day) than when they were using hounds and compared with Game Licence holders in general.

## 4.4 Assumptions

The estimates of the harvest for each deer species were derived based on the assumption that the samples of respondents were representative of the entire population of Victorian Game Licence holders endorsed to hunt deer. This assumption may have been violated due to several factors, such as bias due to reasons for non-response [due to exceeded bag limit, or (conversely) not harvesting anything], memory recall (respondents not remembering their harvest), and deliberate over- or under-reporting (reported numbers knowingly being reported incorrectly). Any bias due to non-response is likely to have been negligible, because the response rate for all surveys was generally above 95% (i.e. very high). Memory bias can inflate estimates of total harvest, in some cases by as much as 40% (Wright 1978; Barker 1991). It is likely, however, that the sampling strategy of telephone interviews after each 2-month period would have ensured that both memory bias and non-response bias were kept low (compared with postal surveys and complete end-of-season surveys) (Barker 1991; Barker et al. 1992). Nevertheless, some bias likely remains, and the estimates of total harvest should be interpreted with care.

It should be noted that the number of hunting days was only an approximate estimate of total effort. Note, someone who hunted for 2 hours and someone else who hunted for 12 hours were both recorded as having hunted for 1 day.

It is important to note that the methodology explicitly accounts for the possibility that not every Game Licence holder hunts in every survey period (see Gormley and Turnbull 2010). Therefore, the estimate of total season bag per Game Licence holder is the sum of the 'harvest per Game Licence holder', not the sum of the 'harvest per hunter'.

The uncertainty in the estimates of total harvest (as indicated by the confidence intervals) was due to two factors. First, there was variation in the reported numbers of animals harvested between respondents who had hunted (see Figure 1 and Figure 4). For example, within a given survey period, some respondents indicated that they hunted unsuccessfully, whereas others took multiple trips and indicated a total harvest of more than 5 deer during the same period. The second source of uncertainty was due to sampling of hunters, rather than taking a complete census; however, the degree of sampling uncertainty was reduced by having sample sizes of 200 respondents per deer hunting survey. Statistically, these sample sizes are considered adequate for providing reasonable estimates.

The spatial distributions of the deer harvest should also be interpreted with care. Grouping the harvest by CMA provides a broad-scale view of the distribution of the harvest. Grouping by smaller regions would provide a finer-scale representation, but this would be at the cost of increased bias in many regions. Because the data are from a sample of Game Licence holders rather than a complete census, it is likely that some areas that were actually hunted are shown as having a zero harvest if no respondents that hunted those areas were contacted. This would be increasingly likely at finer spatial scales. Furthermore, respondents were only asked to report the nearest town to where they hunted, not the actual location. It is, therefore, possible that the nearest town was in a different CMA region than that of the hunting location.

The analysis of Sambar Deer harvested using hounds required an assumption that the respondents were independent within a survey period, that is, the respondents within a survey were not part of the same team during that survey period. If they were, then there is a potential that we double-counted their harvest, increasing the estimated average harvest.

## References

- Barker, R.J. (1991). Nonresponse bias in New Zealand waterfowl harvest surveys. *Journal of Wildlife Management* **55**, 126–131.
- Barker, R.J., Geissler, P.H. and Hoover, B.A. (1992). Sources of nonresponse to the federal waterfowl hunter questionnaire survey. *Journal of Wildlife Management* **56**, 337–343.
- Game Management Authority. 2020. *Game Hunting in Victoria*. <http://www.gma.vic.gov.au> (accessed 1/1/2021).
- Gormley, A.M. and Turnbull, J.D. (2009). *Estimates of harvest for deer, duck and quail in Victoria: results from surveys of Victorian Game Licence holders in 2009*. Arthur Rylah Institute for Environmental Research Technical Report Series No. 196. Department of Sustainability and Environment, Heidelberg, Victoria.
- Gormley, A.M. and Turnbull, J.D. (2010). *Estimates of harvest for deer, duck and quail in Victoria: results from surveys of Victorian Game Licence holders in 2010*. Arthur Rylah Institute for Environmental Research Technical Report Series No. 210. Department of Sustainability and Environment, Heidelberg, Victoria.
- Gormley, A.M. and Turnbull, J.D. (2011). *Estimates of harvest for deer, duck and quail in Victoria: results from surveys of Victorian Game Licence holders in 2011*. Arthur Rylah Institute for Environmental Research Technical Report Series No. 224. Department of Sustainability and Environment, Heidelberg, Victoria.
- Moloney, P.D. and Hampton, J.O. (2020). *Estimates of the 2019 deer harvest in Victoria: results from surveys of Victorian Game Licence holders in 2019*. Arthur Rylah Institute for Environmental Research Unpublished Client Report for the Game Management Authority. Department of Environment, Land, Water and Planning, Heidelberg, Victoria.
- Moloney, P.D. and Powell, Z. (2019). *Estimates of the 2018 deer harvest in Victoria: results from surveys of Victorian Game Licence holders in 2018*. Arthur Rylah Institute for Environmental Research Unpublished Client Report for the Game Management Authority. Department of Environment, Land, Water and Planning, Heidelberg, Victoria.
- Moloney, P.D. and Turnbull, J.D. (2012). *Estimates of harvest for deer, duck and quail in Victoria: results from surveys of Victorian Game Licence holders in 2012*. Arthur Rylah Institute for Environmental Research Technical Report Series No. 239. Department of Sustainability and Environment, Heidelberg, Victoria.
- Moloney, P.D. and Turnbull, J.D. (2013). *Estimates of harvest for deer, duck and quail in Victoria: results from surveys of Victorian Game Licence holders in 2013*. Arthur Rylah Institute for Environmental Research Technical Report Series No. 251. Department of Environment and Primary Industries, Heidelberg, Victoria.
- Moloney, P.D. and Turnbull, J.D. (2014). *Estimates of harvest for deer, duck and quail in Victoria: results from surveys of Victorian Game Licence holders in 2014*. Arthur Rylah Institute for Environmental Research Unpublished Client Report for the Game Management Authority. Department of Environment, Land, Water and Planning, Heidelberg, Victoria.
- Moloney, P.D. and Turnbull, J.D. (2016). *Estimates of harvest for deer in Victoria: results from surveys of Victorian Game Licence holders in 2014 and 2015*. Arthur Rylah Institute for Environmental Research Unpublished Client Report for the Game Management Authority. Department of Environment, Land, Water and Planning, Heidelberg, Victoria.
- Moloney, P.D. and Turnbull, J.D. (2017). *Estimates of deer harvest in Victoria: results from surveys of Victorian Game Licence holders in 2016*. Arthur Rylah Institute for Environmental Research Unpublished Client Report for the Game Management Authority. Department of Environment, Land, Water and Planning, Heidelberg, Victoria.
- Moloney, P.D. & Turnbull, J.D. (2018). *Estimates of the 2017 deer harvest in Victoria: results from surveys of Victorian Game Licence holders in 2017*. Arthur Rylah Institute for Environmental Research Unpublished Client Report for the Game Management Authority. Department of Environment, Land, Water and Planning, Heidelberg, Victoria.
- Wright, V.L. (1978). Causes and effects of biases on waterfowl harvest estimates. *Journal of Wildlife Management* **42**, 251–262.

## Appendices

### Appendix 1: Questionnaire for Game Licence holder endorsed to hunt deer

#### Survey details:

Period of survey \_\_\_\_\_ (1 to 6)

Date of interview: \_\_ (dd) / \_\_ (mm) / 2020

Non-responsive:  (tick box)

#### Survey questions:

1. What is the main species of deer that you hunt? (Sambar, Fallow, Red, Chital, Hog, Rusa)?
2. What is your main hunting method? (Stalking, Stalking with a gundog, Hound hunting, Bow hunting, Spotlighting)
3. Have you been deer hunting in the past 2 months? (Jan and Feb) Yes  No  (Tick box.)  
(If 'Yes', proceed to question 4, if 'No', say, "Thank you for taking part in this survey.")
4. How many deer hunting trips have you taken over this 2-month period?

(Each trip needs to be treated separately for questions 5–11.)

5. On how many days did you go hunting?
6. How many deer did you harvest?  
[When a hunter says he has harvested deer by hound hunting (scent trailing hounds), check that it was what the individual got and not the group.]
6. Did you shoot and lose any deer? If yes, how many?
7. What species were the deer?
  - Sambar
  - Fallow
  - Red
  - Hog
  - Chital
  - Rusa

8. What was the sex of the deer?

Number of males?

Number of females?

9. How were the deer taken?

- Stalking with a rifle
- Stalking with a rifle and gundog
- Scent-hounds
- Bow
- Crossbow
- Shotgun
- Muzzle loader

10. Did you hunt on private land or public land? Public  Private  Both

11. What was the closest major town to the area in which you hunted?

## Appendix 2: Questionnaire for Game Licence holder endorsed to hunt deer using hounds

### Survey details:

Period of survey \_\_\_\_\_ (1 to 4)

Date of interview: \_\_ (dd) / \_\_ (mm) / 2020

Non-responsive:  (tick box)

### Survey questions:

1. Have you been hound hunting in the past 2 months? (Oct and Nov) Yes  No  (Tick box)  
(If 'Yes', proceed to question 2, if 'No', go to Q 10. If no to that, say "Thank you for taking part in this survey.")

2. How many hound hunting trips have you taken over this 2-month period?  
(Indicate number in box)

(Each trip needs to be treated separately for questions 3–8.)

3. On how many days did you go hunting?

4. How many hunters in your team?

5. How many deer did your team harvest?

6. How many deer did you harvest?

7. What was the sex of the deer?

Number of males?

Number of females?

8. Did you hunt on private land or public land? Public  Private  Both

9. What was the closest major town to the area in which you hunted?



10. Have you been deer hunting without hounds in the past 2 months? Yes  No

11. How many non-hound hunting trips have you taken over this 2-month period?

12. How many days did you go hunting?

13. How many deer did you harvest?

## Appendix 3: Definitions and calculations

### Common definitions used

SD = standard deviation of the data; it represents the variation in the numbers reported.

SE = standard error of the mean; it represents the variation in the estimated mean.

CV = coefficient of variation; it is calculated as:  $CV = SE \div \text{mean}$ . This provides an indication as to how much uncertainty is in the estimate relative to the mean.

### Calculations

For each survey  $j$ , we surveyed  $n_j$  respondents, of which  $h_j$  had hunted. The proportion of respondents who hunted in each period  $j$  is given by:

$$p_j = \frac{h_j}{n_j} \text{ e.g. for Deer Survey 4 in 2015, we obtained: } \frac{70}{200} = 0.350 .$$

The total number of hunters for each survey period ( $H_j$ ) was estimated by multiplying the total number of licence holders ( $L$ ) by the proportion of respondents who reported having hunted during that survey period ( $p_j$ ), as found previously:

$$H_j = p_j L \quad \text{e.g. for Deer Survey 4 in 2015, we obtained: } 0.35 \times 30,908 = 10,818.$$

The estimated average harvest per hunter ( $w_j$ ) is the total reported harvest for survey  $j$  ( $y_j$ ) divided by the total number of respondents who hunted ( $h_j$ ):

$$w_j = \frac{y_j}{h_j} \quad \text{e.g. for Deer Survey 4 in 2015, we obtained: } \frac{215}{70} = 3.07 .$$

The total harvest for each survey period ( $W_j$ ) was estimated by multiplying the average harvest per hunter ( $w_j$ ) by the total number of hunters ( $H_j$ ):

$$W_j = w_j H_j \quad \text{e.g. for Deer Survey 4 in 2015, we obtained: } 3.07 \times 10,808 = 33,226 .$$

The estimate of the total harvest was calculated as the sum of the estimated harvest for each survey period:

$$W_{TOT} = W_1 + W_2 + W_3 + W_4 + W_5 + W_6 .$$

Standard errors (SEs) for the proportion of respondents who hunted are given by:

e.g. for Deer Survey 4 in 2015, we obtained: .

Standard errors for the average harvest per hunter are given by:

$$\text{e.g. for Deer Survey 4 in 2015, we obtained: } \frac{4.55}{\sqrt{70}} = 0.54 .$$

The standard error for the total estimated harvest per survey period ( $W_j$ ) was found by determining the coefficient of variation (CV) for each  $p_j$  and  $w_j$  and then calculating the square root of the sum of their squares to find the combined CV (assuming independence).

$$CV(w_j) = \frac{SE(w_j)}{w_j}, \text{ and } CV(p_j) = \frac{SE(p_j)}{p_j}$$

$$CV(W_j) = \sqrt{(CV(w_j))^2 + (CV(p_j))^2}$$

$$SE(W_j) = CV(W_j) \times W_j .$$

The standard error of the total harvest was calculated as follows:

$$SE(W_{TOT}) = \sqrt{(SE(W_1))^2 + (SE(W_2))^2 + \dots + (SE(W_6))^2} .$$

Confidence intervals were computed on the natural logarithm scale and back-transformed to ensure that lower limits were  $\geq 0$ . A consequence is that the confidence intervals were asymmetric and could not be reported as the estimate plus or minus a fixed value. For some estimates, denoted as, 95% confidence interval limits were calculated using:

*upper limit (UL)*

*lower limit (LL)* , where:

$$r = \exp\left(1.96\sqrt{\ln(1 + CV^2)}\right) ,$$

e.g. for the total deer harvest in 2015 we have

$$CV = \frac{8,349}{71,142} = 0.117$$

Therefore, upper and lower confidence limits are given by:

$$UL = 71,142 \times 1.26 = 89,471$$

$$LL = 71,142 \div 1.26 = 56,567 .$$

## Appendix 4: Explanation of what goes into a boxplot

A boxplot is a way of displaying key points of the data and is especially good for comparing groups of data. It is sometimes referred to as a box-and-whisker plot. A boxplot shows the following key points:

- outliers, signified by hollow circles
- minimum, signified by the horizontal line below the box (smallest value, excluding outliers)
- lower quartile (Q1), signified by the horizontal line at the bottom of the box (25% of the data is at this point or below)
- median, signified by the thick horizontal line in the box (50% of the data is at this point or below)
- upper quartile (Q3), signified by the horizontal line at the top of the box (75% of the data is at this point or below)
- maximum, signified by the horizontal line above the box (largest value, excluding outliers)
- interquartile range (IQR; difference between the upper and lower quartiles)
- whiskers—the lines that go from the minimum or maximum to the box.

Outliers are values that are very large (or small) compared with the rest of the data. An outlier is defined as any point that is either below  $Q1 - 1.5 \times IQR$  or above  $Q3 + 1.5 \times IQR$ , which means that any point that lies more than one-and-a-half times the length of the box outside the box is an outlier.

The boxplot indicates the spread of the data. The data is broken into quarters: approximately 25% of the data are in the range between a whisker and the nearest edge of the box, and approximately 25% of the data are in the range between an edge of the box and the median line. Thus, approximately half the data are thus contained within the box. Any unusual data are highlighted as outliers. As an example, using duck hunting, Figure A4.1 shows a boxplot indicating that most hunters harvested between 5 and 13 ducks, and a quarter harvested between 13 and 27 ducks. A number of outliers harvested more than 27 ducks, including one who harvested over 50 ducks. Sometimes there are no whiskers because the minimum (or maximum) is the same as the lower (or upper) quartile (see Figure A4.1, which indicates that at least 25% of Game Licence Holders who hunted were unsuccessful).

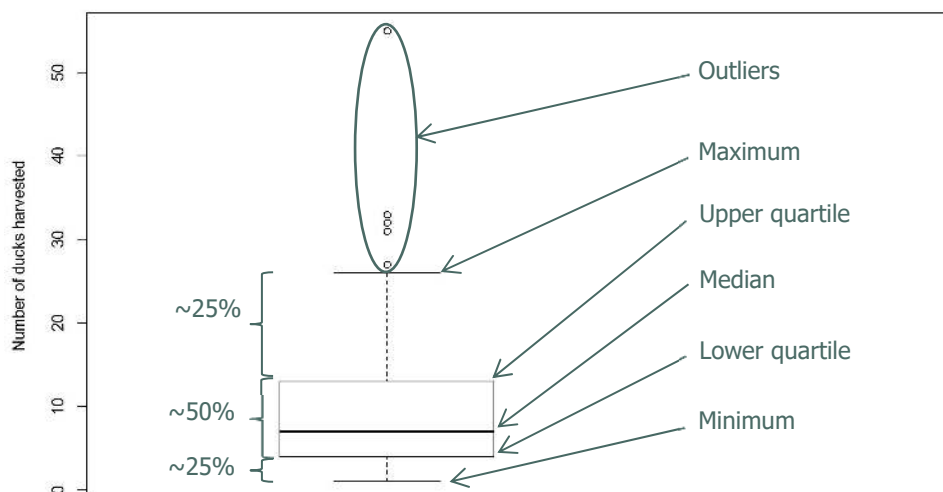

Figure A4.1: Example boxplot, with labels

## Appendix 5: Harvest rates per Game Licence endorsed for hunting deer

The total average season harvest was 1.8 deer per Game Licence holder (95% CI = 1.3–2.5; Table A5.1). Note that, for each survey period, the average deer harvested per Game Licence holder (Table A5.1) was much lower than the average deer harvested per Game Licence holder who hunted (Table 3), because the former included those respondents who did not hunt during the survey period.

**Table A5.1: Estimates of average harvest of deer per Game Licence holder in each survey period in 2020**

Period	Average harvest <sup>13</sup>	SE	95% CI	
			Lower	Upper
Jan–Feb	0.14	0.04	0.08	0.26
Mar–Apr	0.36	0.16	0.16	0.84
May–Jun	0.43	0.21	0.17	1.06
Jul–Aug	0.34	0.09	0.21	0.55
Sep–Oct	0.42	0.10	0.27	0.67
Nov–Dec	0.10	0.06	0.04	0.28
<b>Total harvest per licence holder</b>	<b>1.80</b>	<b>0.30</b>	<b>1.29</b>	<b>2.50</b>

Each Game Licence holder endorsed to hunt deer hunted an average of 3.7 days during 2020 (Table A5.2), corresponding to a total of 143,488 hunter days (95% CI = 114,800–179,344).

**Table A5.2: Number of days on which deer were hunted per Game Licence holder for 2020**

Period	Days hunted	SE	95% CI	
			Lower	Upper
Jan–Feb	0.42	0.10	0.26	0.66
Mar–Apr	0.46	0.12	0.27	0.78
May–Jun	0.80	0.15	0.55	1.16
Jul–Aug	0.64	0.12	0.45	0.91
Sep–Oct	1.12	0.21	0.78	1.62
Nov–Dec	0.24	0.07	0.13	0.41
<b>Total hunting days per licence holder</b>	<b>3.68</b>	<b>0.34</b>	<b>3.08</b>	<b>4.40</b>

<sup>13</sup> Average harvest per Game Licence holder = Deer harvested divided by Respondents (Table 1).

## Appendix 6: Harvest rates per Game Licence holders endorsed for using hounds

The total average season harvest was 1.9 deer per Game Licence holder using hounds (95% CI = 1.6–2.4; Table A6.1). Note that, for each survey period, the average deer harvest per hound team member (Table A6.1) was much lower than the average deer harvest per Game Licence holder who hunted using hounds (Table 13), because the former included those respondents who did not hunt with hounds during the survey period.

**Table A6.1: Estimates of average harvest of deer per Game Licence holder using hounds in each survey period in 2020**

Period	Average harvest <sup>14</sup>	SE	95% CI	
			Lower	Upper
Apr–May	0.20	0.04	0.13	0.31
Jun–Jul	0.99	0.16	0.72	1.35
Aug–Sep	0.29	0.06	0.19	0.44
Oct–Nov	0.46	0.11	0.30	0.72
<b>Total harvest per licence holder</b>	<b>1.94</b>	<b>0.21</b>	<b>1.57</b>	<b>2.39</b>

The average number of hound hunting days in each survey period varied throughout the season, with most hunting occurring from late autumn to mid-spring. Each Game Licence holder endorsed to hunt deer using hounds hunted an average of 3.8 days during 2020 (Table A6.2).

**Table A6.2: Number of days on which deer were hunted using hounds per Game Licence holder endorsed for using hounds for 2020**

Period	Days hunted	SE	95% CI	
			Lower	Upper
Apr–May	0.45	0.10	0.29	0.69
Jun–Jul	1.77	0.41	1.13	2.78
Aug–Sep	0.97	0.27	0.57	1.65
Oct–Nov	0.65	0.17	0.40	1.08
<b>Total harvest per licence holder</b>	<b>3.84</b>	<b>0.53</b>	<b>2.93</b>	<b>5.03</b>

<sup>14</sup> Average harvest per Game Licence holder endorsed for using hounds.

